

A technical drawing in white lines on a dark background, showing a perspective view of a modular shelving system. It includes a vertical support structure, a horizontal shelf, and a base. The drawing uses hatching for shading and is overlaid on a photograph of a dark metal shelving component.

Модульная система

Modular shelving system

stilPHOS

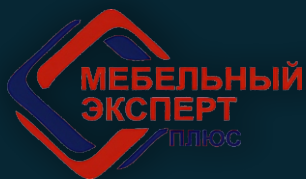

STILPHŌS







Конструкція від підлоги до стелі Stili floor to ceiling composition

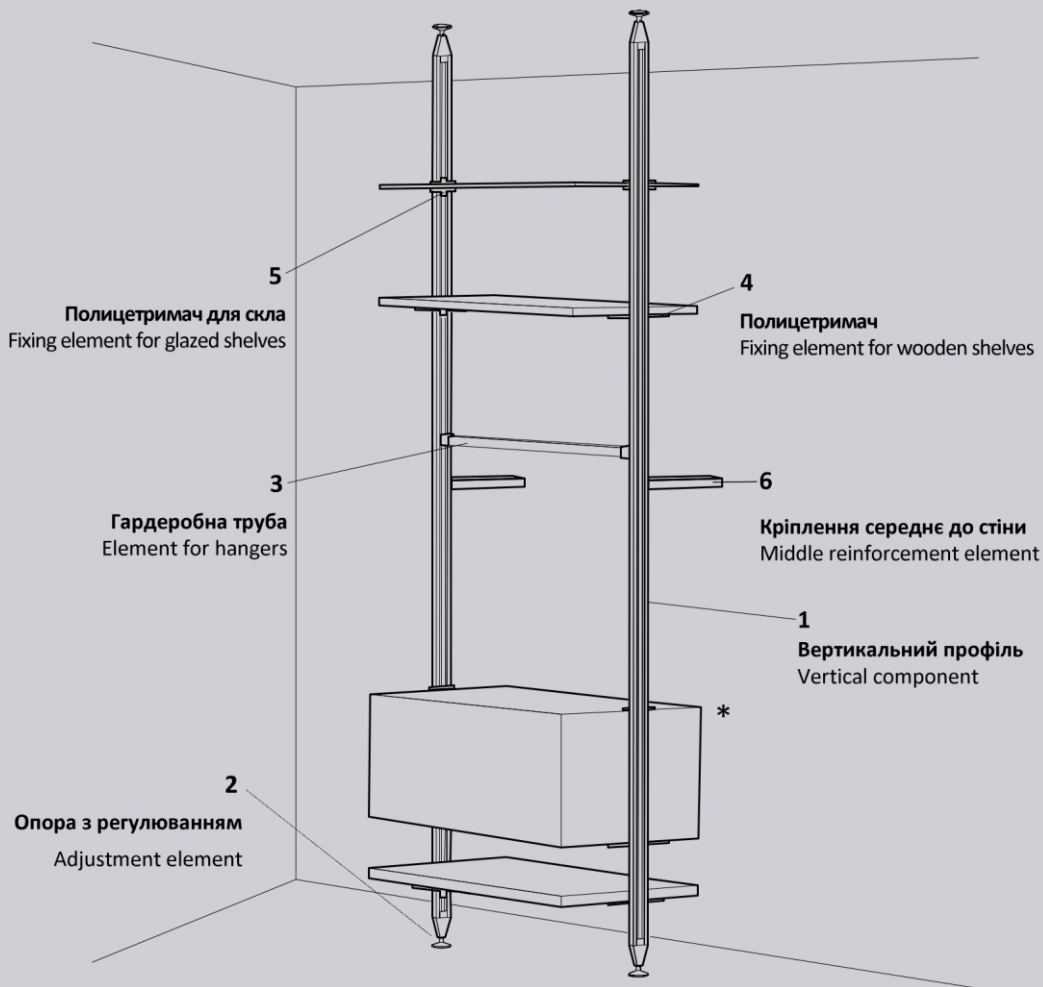

* Підвісну шухляду рекомендовано прикріплювати до стіни.
The storage box shall always be fixed to the wall.



Конструкція від підлоги до стіни Stíli floor to wall composition

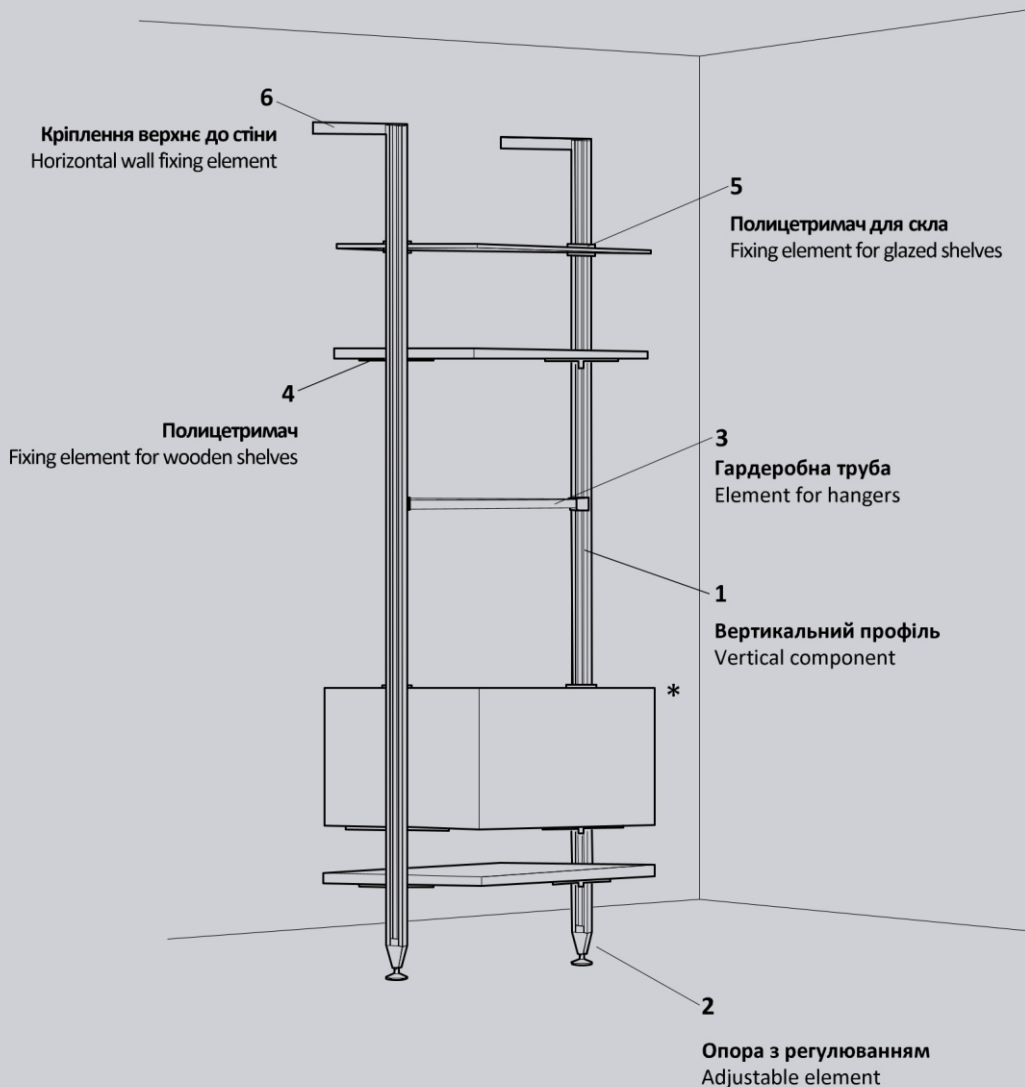

*Підвісну шухляду рекомендовано прикріплювати до стіни.
The storage box shall always be fixed to the wall.



Анодоване покриття

Anodised finishes

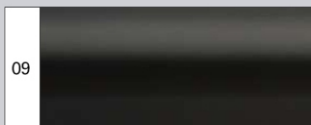

Чорний

Black anodised brushed aluminum



Олива

Olive gray brushed

Фарбоване покриття

Painted finishes



Антрацит

Stardust

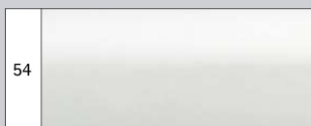

Білий

Matt white varnished aluminum



Аксессуары Accessories

Вертикальный профиль Closed vertical structural profile

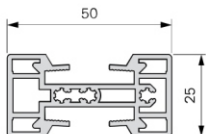

Код				
	mm	pcs	kg	pcs
MNPVXLXX	5.200	41,6	45	41,6

Вертикальный профиль под LED Open vertical structural profile

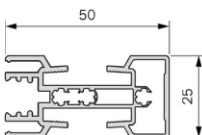
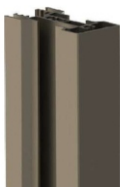

Код				
	mm	pcs	kg	pcs
MNPVXX	4.800	38,4	40	38,4

Розсіювач під LED-освітлення LED shield



Код				
	mm	pcs	kg	pcs
MNSLP2800	2.800	28	2,5	28

Опора регулируемая Adjustable element kit

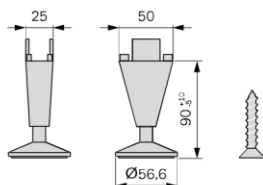

Код				
	mm	pcs	kg	pcs
MGKT01ALXX	90	50	11	50
MGKT01PLXX	90	50	8	50

Аксессуары Accessories

Кріплення до стелі Adjustable element kit

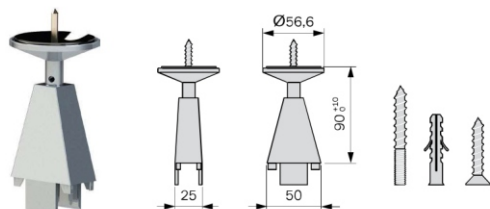

Код				
	mm	pcs	kg	pcs
MGKT10ALXX	90	50	11	50
MGKT10PLXX	90	50	8	50

Кріплення верхнє до стіни Upper wall connection element

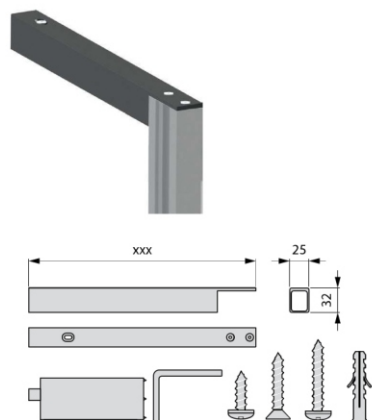

Код				
	mm	pcs	kg	pcs
MNKT05150XX	150	50	13	50
MNKT05220XX	220	50	15	50
MNKT05295XX	295	50	17	50
MNKT05345XX	345	50	20	50
MNKT05320XX	320	50	19	50

Кріплення середнє до стіни Mid wall connection element

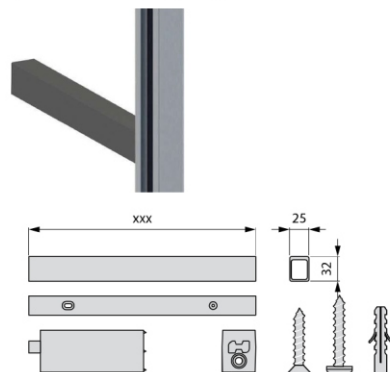



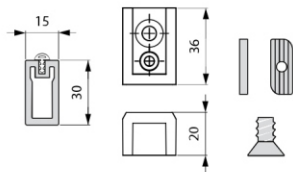

Код				
	mm	pcs	kg	pcs
MGKT06170XX	170	50	10	50
MGKT06295XX	295	50	12	50
MGKT06245XX	245	50	12	50

Аксессуары Accessories





Труба гардеробна в комплекті з тримачами Element for hangers with gasket

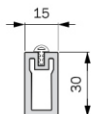

Код				
	mm	pcs	kg	pcs
MNKT020600XX	60/90/120	10	4	10
MNKT020900XX	60/90/120	10	6	10
MNKT021200XX	60/90/120	10	8	10





Труба гардеробна Tube for hangers with gasket

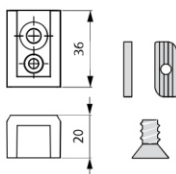

Код				
	mm	pcs	kg	pcs
MGTAXLXX	4800	48	35	48

Комплект тримачів гардеробної труби Hangers accessories kit



Код				
	mm	pcs	kg	pcs
MNKT02AXX	--	25	0,5	25

Полицетримач для ДСП (довжиною 160 мм) Fixing element for wooden shelves

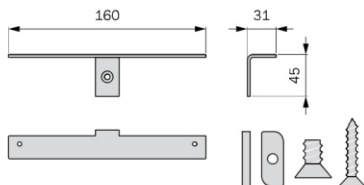

Код				
	mm	pcs	kg	pcs
MNKT03XX	160	25	7	25

Аксессуары Accessories

Полицетримач для скла Fixing element for glass shelves

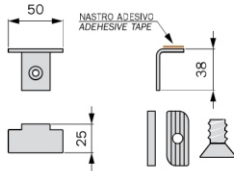

Код				
	pcs	kg	pcs	pcs
MNKT04XX	50	25	4	25

Полицетримач для ДСП (довжиною 240 мм) Fixing element for shelves

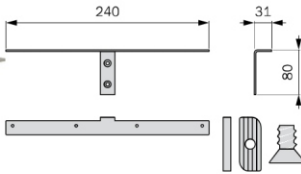

Код				
	pcs	kg	pcs	pcs
MNKT16XX	240	25	4	25

Комплект тримачів Drawer unit kit

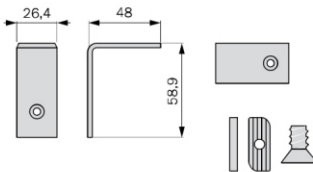

Код				
	pcs	kg	pcs	pcs
MN/КТ18XX	--	25	4	25

Використовувати тільки тоді, коли шухляда прикріплена до стіни за допомогою відповідних кріплень.
To be used only when the chest of drawers is attached to the wall with appropriate hardware.

Тримач ДСП до стіни Mid fixing element for shelf

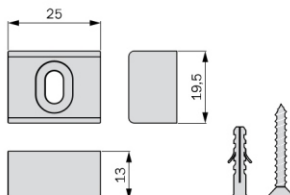

Код				
	pcs	kg	pcs	pcs
MNKT19PLXX	25	25	2	25

Аксессуары Accessories



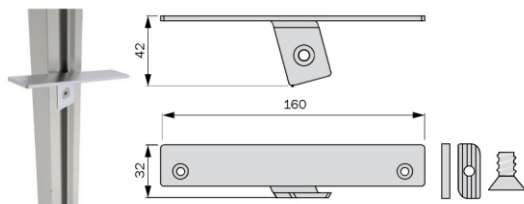

Елемент кріплення полиці для взуття Shoe rack fixing element

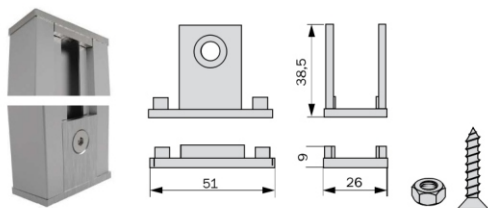

Код				
	pcs	kg	pcs	pcs
MNKT11XX	160	25	4	25





Кріплення до стільниці з заглушкою Worktop kit with cap

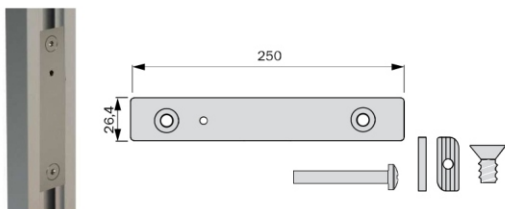

Код				
	pcs	kg	pcs	pcs
MNKT23XX	--	25	4	25

Кріплення для тумб бокове (приховане) Drawer fixing element





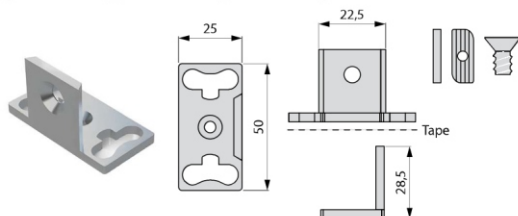

Код				
	pcs	kg	pcs	pcs
MNKT20XX	--	25	4	25

Використовується в поєднанні з кодом MNKT22xx.
To be used in combination with code MNKT22xx.

Кріплення до стільниці Worktop connection



Код				
	pcs	kg	pcs	pcs
MNKT17PLXX	--	25	2	25

Аксессуары Accessories

Комплект тримачів тумби Kit drawer

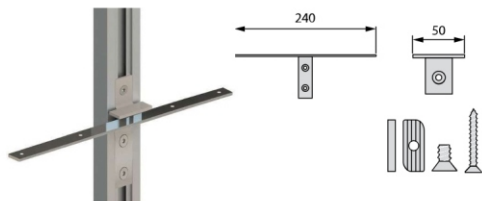

Код			
	pcs	kg	pcs
MNKT22XX	--	25	4 25

Для встановлення шухляди без верхнього кронштейна, будь ласка, використовуйте MNKT20.
For drawer installation without upper bracket, please use MNKT20.



м. Одеса, вул.Дальницька, 25
тел. вайбер. +380950153906,
+380974541655
sale@mep.com.ua

